

# Chromalox®

## Installation Instructions

NOTICE: These thermostats are designed for temperature control service only. Because they may not fail safe, they should not be used for temperature limiting duty.

**WARNING: Users should install adequate back-up controls and safety devices with their electric heating equipment. Where the consequences of failure may be severe, back-up controls are essential. Although the safety of the installation is the responsibility of the user, Chromalox will be glad to make equipment recommendations.**

### SERVICE REFERENCE

DIVISION 4	SECTION RT
SALES REFERENCE (Supersedes PJ454-5)	PJ454-6
161-562765-001	
DATE	JANUARY, 2009

## RTBC and RTBC-EP Power Connection Kit With Integral Thermostat



### RTBC Kit Parts:

- 1 — Molded Enclosure consisting of Base — Box — Lid
- 1 — Three Position Terminal Block
- 1 — Mounting Screw for Terminal Block
- 1 — Uninsulated Barrel Connector (RTBC-EP Only)
- 1 — Eight Inch Length of 14AWG Insulated Wire with Connector (RTBC Only)

- 1 — Ring Connector (RTBC Only)
- 1 — Thermostat with Mounting Screws (2)
- 1 — Capillary Grommet
- 1 — Cover Gasket
- 4 — Cover Screws, 5/8" Long
- 4 — Box Screws, 1" Long

### GENERAL

**WARNING: Hazard of Electric Shock. Disconnect all power before starting. All installations must be effectively grounded in accordance with the National Electrical Code to eliminate shock hazard.**

**Note:** All electrical wiring, including GFCI (Ground Fault Circuit Interrupters), must be done according to National Electrical or local codes by a qualified person.

These kits are designed to provide temperature control as well as power termination for one run of Rapid Trace Heating Cable. Select and purchase one grommet for terminating the cable. Please refer to the list below to insure that you purchase the proper grommet for the cable you are installing.

- GR1 for SRL-C
- GR2 for SRL-CR or SRL-CT

- GR3 for CWM-C
- GR4 for CWM-CT
- GR5 for SRL-MC
- GR6 for SRL-MCR or SRL-MCT
- GR7 for SRM/E-C
- GR8 for SRM/E-CT

Each kit contains enough material to make one power connection. Materials required for installation include: Standard electrical cutters, sharp utility knife, screwdriver and a pipestrap (Chromalox PS type or equal).

Wipe inside lip of cover with a clean cloth. Removing protective backing from the gasket and affix it to the cover lip. Press firmly all around for proper adhesion.

### INSTALLATION

**Note:** These instructions are for all Self-Regulating and Constant Wattage Heating Cables in ordinary locations. Consult factory for installation of braided cable in hazardous locations. Not all instructions, however, are for all cases. Each step of the instructions will have a heading in boldface stating which type of cable or connection each instruction is intended for.

#### 1. FOR CONSTANT WATTAGE CABLE:

Cut the cable 12 inches past the last module point (indentation in cable). **Note:** Cutting the cable between module points creates a non-heating cold lead. See Figure 1.

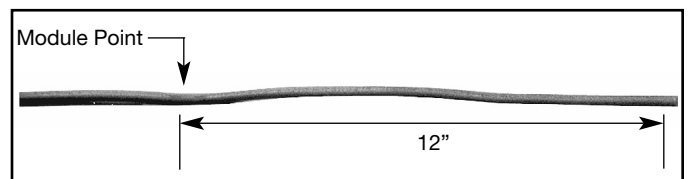

Figure 1

## INSTALLATION

- 2. FOR CABLE WITH EXPOSED METAL BRAID (-C):**  
Push the braid back 12 inches on the cable. See Figure 2.



Figure 2

- 3. FOR ALL CABLE:**  
Feed the end of the cable through the appropriate hole in the base. Allow 8 inches of cable to extend above the top of the base. See Figure 3.
- 4. FOR ALL CABLE:**  
Slide cable grommet over the end of the cable and insert it into the opening in the base. Attach the base to the pipe by threading the appropriate sized pipestrap through the slot in the mounting plate. Tighten the pipestrap until the base is loosely attached to the pipe. See Figure 4.

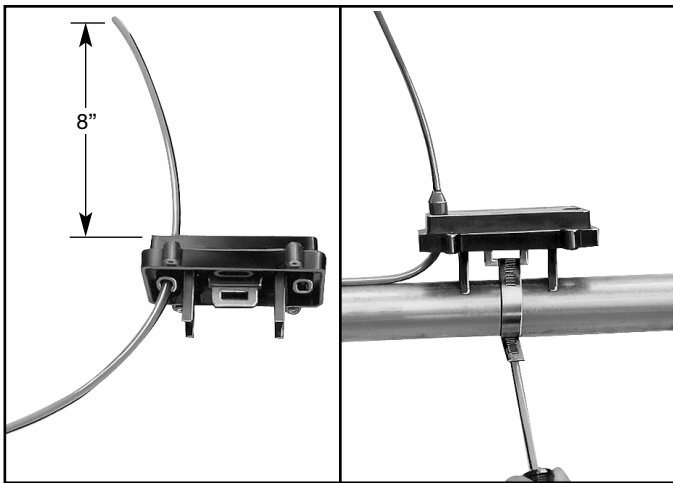

Figure 3

Figure 4

- 5. FOR OVERCOATED CABLES (-CR or -CT):**  
Score the outer insulation 1-1/2 inches from the end of the cable. Remove the jacket to expose the metal braid. See Figure 5. **WARNING:** Do not damage the braid or the base cable insulation.

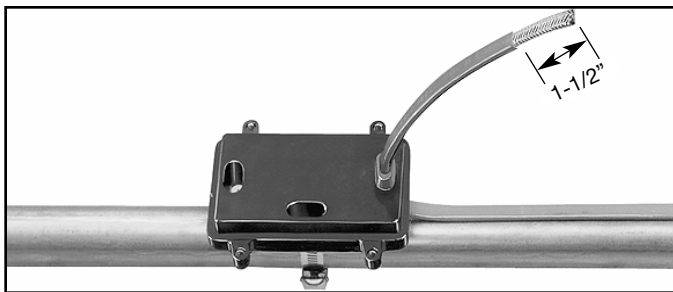

Figure 5

- 6. FOR ALL CABLE:**  
Punch out the knockouts on the bottom of the box which correspond to the openings in the base through which the heating cable passes. For these kits, the openings to be knocked out are the ones opposite the conduit entry and the one by the side of the box. Be careful to punch out only those knockouts to be used. If one is mistakenly punched, blank grommets can be ordered to re-establish the watertight seal. See Figure 6.

- 7. FOR ALL CABLE:**  
Feed the capillary of thermostat through the side hole of the box and side hole of the base. Slip the grommet over the capillary between the box and the base. See Figure 7.

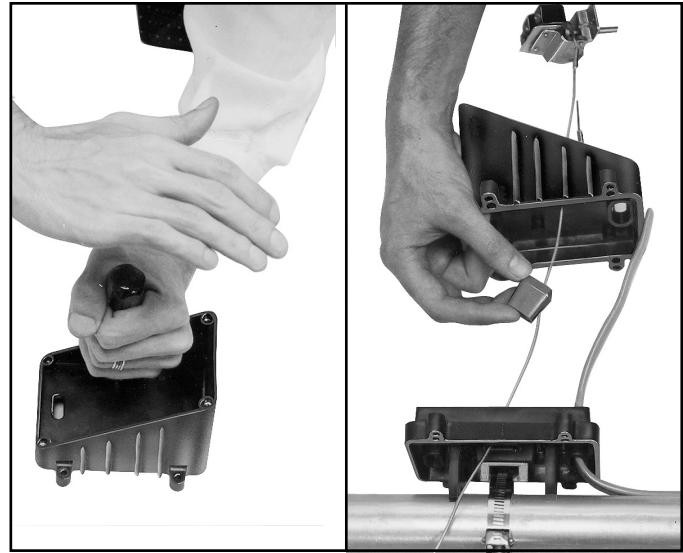

Figure 6

Figure 7

- 8. FOR ALL CABLE:**  
Feed the cable through the end hole in the box. Allow 3/4 inches of stainless steel capillary to extend above the bottom of the box. Secure box to base using all four large (8-32) screws. See Figure 8.
- 9. FOR OVERCOATED CABLE:**  
Starting from the end of the cable, unravel 1-1/2 inches of the

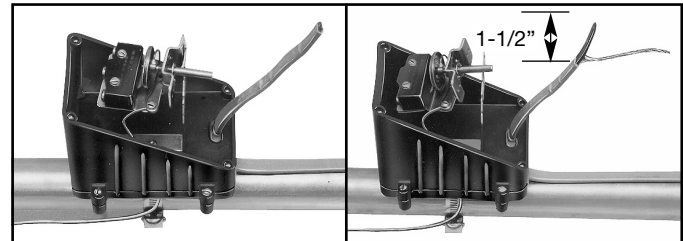

Figure 8

Figure 9

- braid. Twist the strands together to form a pigtail. See Figure 9.
- 10. FOR SELF-REGULATING CABLE:**  
Using standard electrical cutters, cut a 3/4 inch long notch out of the cable between the conductor wires. Bare a 3/8 inch length of each conductor by stripping off the outside insulation and the inner black core material. See Figure 10.
- 11. FOR CONSTANT WATTAGE CABLE:**

- Score the outer jacket 3/4 inch from the end of the cable and remove the jacket. Cut off the exposed nichrome wire, pushing any remainder back under the jacket. Constant Wattage cables have an inner layer of insulation which is also to be removed as described above. Separate the buss wires and strip off the last 3/8 inch of insulation from both buss wires. See Figure 11.

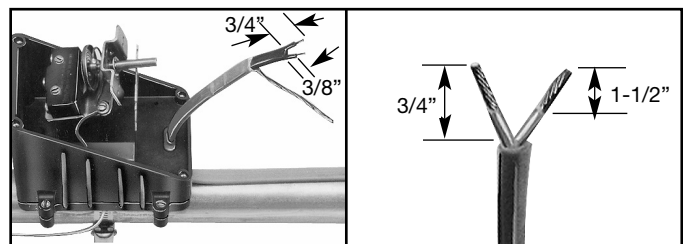

Figure 10

Figure 11

## INSTALLATION

### 12. FOR OVERCOATED CABLE (RTBC ONLY):

Insert the end of the braid pigtail into the opening in the terminal block which will be nearest the center of the box. Tighten the screw firmly to hold the braid in place. See Figure 12.

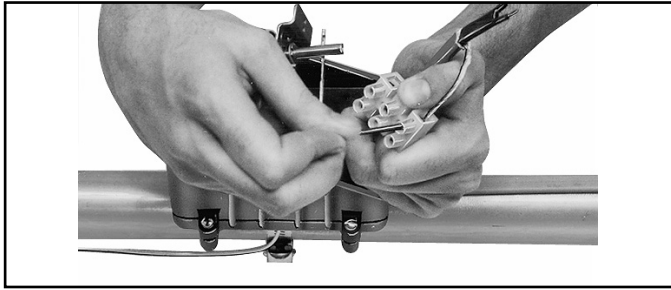

Figure 12

### 13. FOR ALL CABLE:

Insert the bared ends of the conductors into two adjacent openings in the terminal block. Tighten screws firmly to hold conductors in place. See Figure 13.

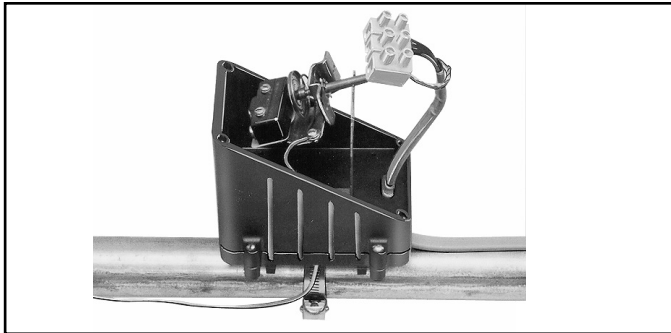

Figure 13

### 14. FOR RTBC ONLY:

Remove the screw and collar from the NORMALLY CLOSED terminal of the thermostat. Discard the collar. Push the screw through the opening in the connector attached to the insulated wire and screw it back into the normally closed terminal. See Figure 14.

### 15. FOR ALL CABLE:

Connect conduit hub (Chromalox CCH-1 or equal) to the box. Attach conduit to hub and bring 8 inches of power leads into the box. See Figure 15.

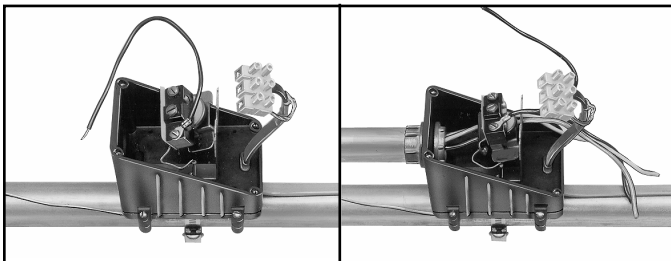

Figure 14

Figure 15

### 16. FOR ALL CABLE:

Strip a 3/8 inch length of each conductor of the power wiring. See Figure 16.

### 17. FOR RTBC ONLY:

Crimp the ring connector onto the end of the "HOT" conductor. Remove the screw and collar from the COMMON terminal. Discard the collar. Push the screw through the opening in the ring connector. Drive the screw back into the COMMON terminal. See Figure 17.

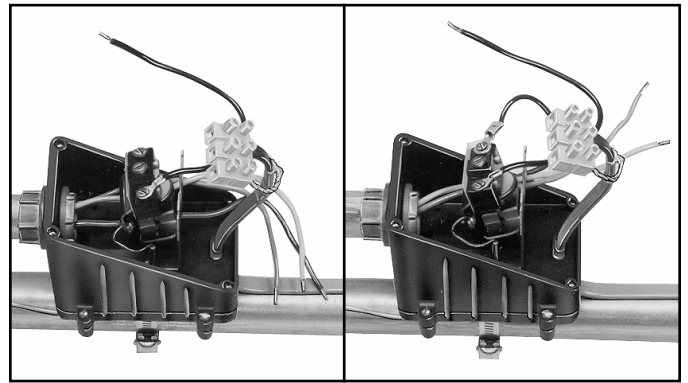

Figure 16

Figure 17

### 18. FOR RTBC ONLY:

Insert the bared end of the ground wire into the opening of the terminal block which is opposite of the braid (or is empty). Insert the ends of the other hot (or neutral) and the 8 inch long wire into the two remaining openings in the terminal block. Tighten screws firmly to hold conductors in place. See Figure 18.

### 19. FOR RTBC-EP ONLY:

Slide the bared end of the hot power lead into the opening in the terminal block which is opposite of the empty terminal. Slide the bared end of the other hot or the neutral power lead into the middle opening of the terminal block. Tighten the screws firmly to hold the wires in place. See Figure 19.

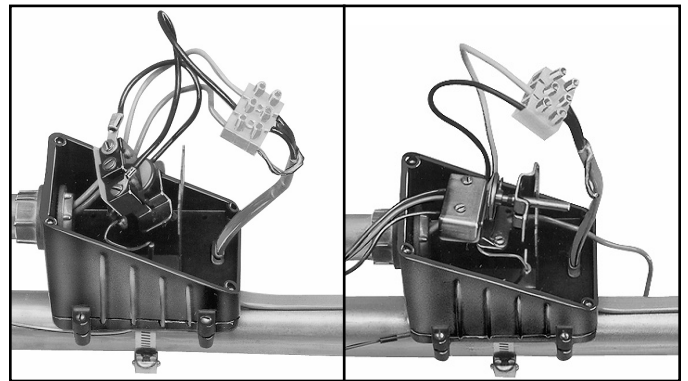

Figure 18

Figure 19

### 20. FOR RTBC-EP ONLY:

A. Slide the bared end of the black (NORMALLY CLOSED) thermostat wire into the opening of the terminal block which is next to the incoming power leads.

B. Slide the bared end of the purple (COMMON) thermostat wire into the opening opposite of the hot power lead. Tighten the screws firmly to hold the wires in place. See Figures 20A and 20B.

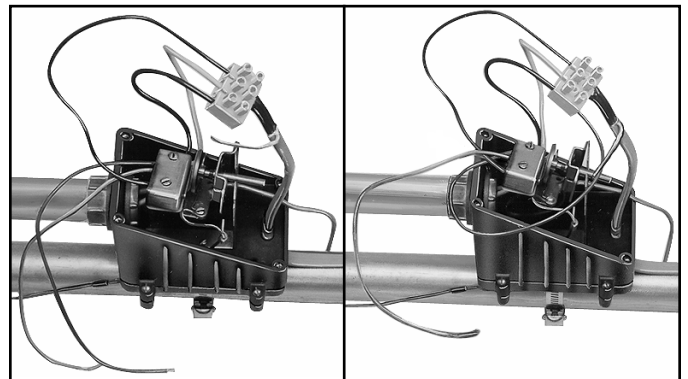

Figure 20A

Figure 20B

## INSTALLATION

### 21. FOR RTBC-EP ONLY:

Trim the blue (NORMALLY OPEN) thermostat wire so that it is only 2 inches long. Tape over the end of the wire using fiberglass tape. See Figure 21.

### 22. FOR RTBC-EP WITH OVERCOATED CABLE ONLY:

Slide the bared end of the ground wire into the end of the uninsulated barrel connector. Crimp it on using a crimping tool. Slide the end of the braid pigtail into the other end of the uninsulated barrel connector and crimp it on. See Figure 22.

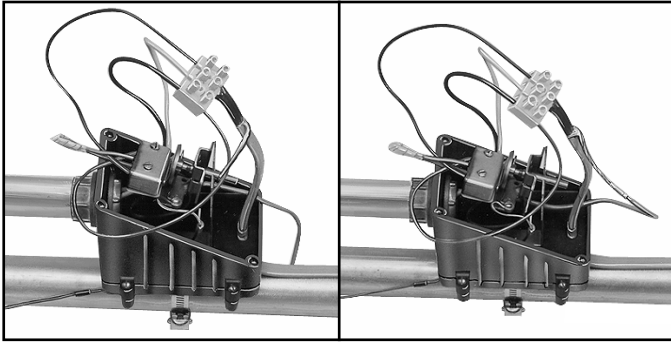

Figure 21

Figure 22

### 23. FOR ALL CABLE:

Mount terminal block to bottom of the box by driving the 6-32 self-tapping screw into the mounting hole as shown. See Figure 23.

### 24. FOR ALL CABLE:

Thread the screws into the outside pair of mounting holes of the thermostat leaving approximately 1/8 inch of thread. Slide the screws into the slots in the mounting bracket. Push the thermostat down as far as it will go and tighten the screws firmly. See Figure 24.

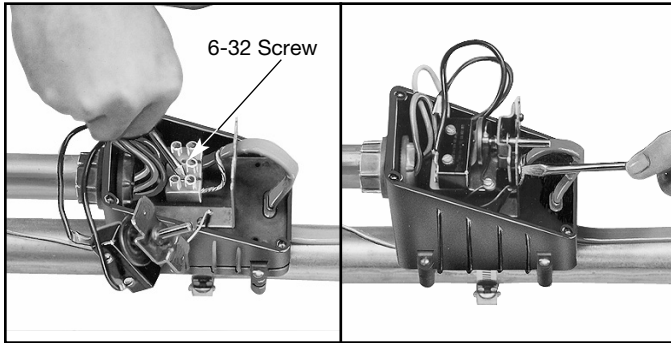

Figure 23

Figure 24

### 25. FOR ALL CABLE:

Push the knob onto the shaft of the thermostat. Adjust thermostat to desired temperature setting. See Figure 25.

### 26. FOR ALL CABLE:

Carefully push wires into the box. Secure lid to box. See Figure 26.

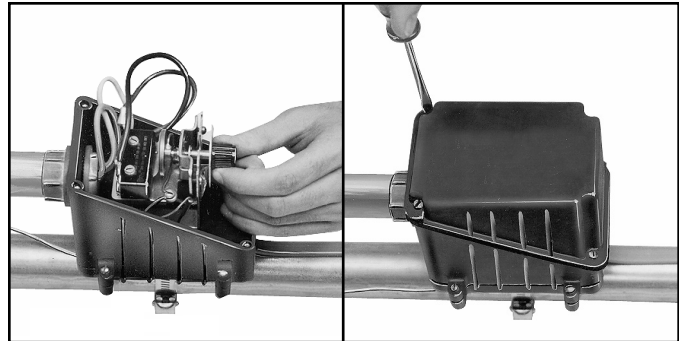

Figure 25

Figure 26

### 27. FOR CABLE WITH EXPOSED METAL BRAID:

Unravel four inches of braid from the cable and twist into a pigtail. Connect to appropriate grounding source. See Figure 27.

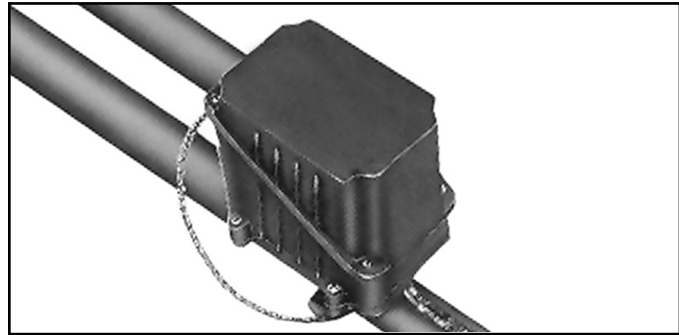

Figure 27

### 28. FOR ALL CABLE:

Extend capillary to allow bulb to be placed in desired location. The bulb should be placed on the bottom half of the pipe spaced 90° from the nearest heating cable or centered between equally spaced heaters. Do not locate the bulb within 3 feet of a pipe support or other heat sink.

### Limited Warranty:

Please refer to the Chromalox limited warranty applicable to this product at [http://www.chromalox.com/customer-service/policies/terms\\_of\\_sale.aspx](http://www.chromalox.com/customer-service/policies/terms_of_sale.aspx).

**Chromalox**<sup>®</sup>  
PRECISION HEAT AND CONTROL

1347 HEIL QUAKER BLVD., LAVERGNE, TN 37086  
Phone: (615) 793-3900 [www.chromalox.com](http://www.chromalox.com)